

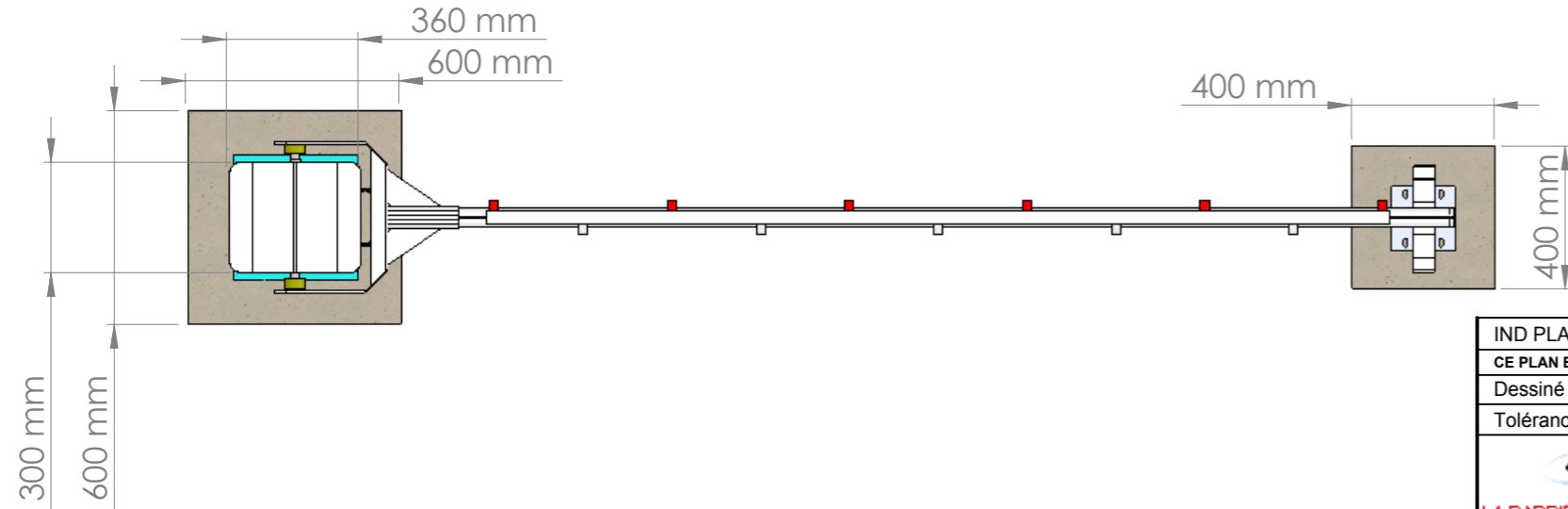

Longueur lisse X en mm	Largeur passage Y en mm	Entraxe massifs Z en mm
4000	3900	4161
4500	4400	4661
5000	4900	5161
5500	5400	5661
6000	5900	6161
6500	6400	6661
7000	6900	7161

IND PLAN	B	MODIFICATION FAIT PAR	MIRKOVIC.Y	DATE	24/02/2014
CE PLAN EST LA PROPRIETE DE LA BARRIERE AUTOMATIQUE. REPRODUCTION OU COMMUNICATION A DES TIERS INTERDITE.					
Dessiné par:	MIRKOVIC.Y	Date:	26/12/2013	Vérifié par:	
Tolérance générale suivant ISO 2768		Classe : mK		Nom Client:	
 451 chemin de Champivost - BP85 69579 LIMONEST Cedex Tel: 04.78.86.02.86 Fax: 04.78.51.18.76 WWW.barriere-automatique.com			Désignation : LBA7 Lisse ovale		
Echelle	1:20			Numero Affaire	
Format	A3			Plan générique	

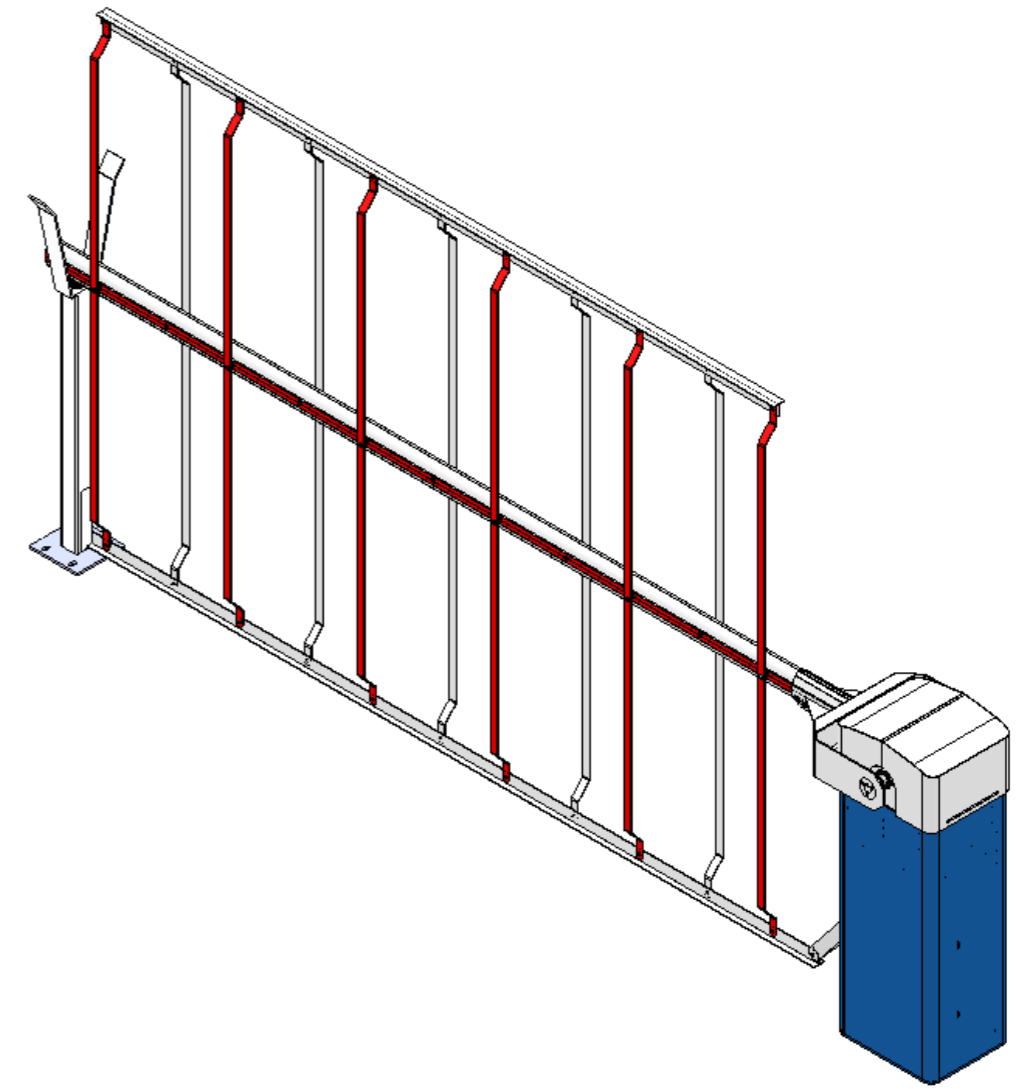
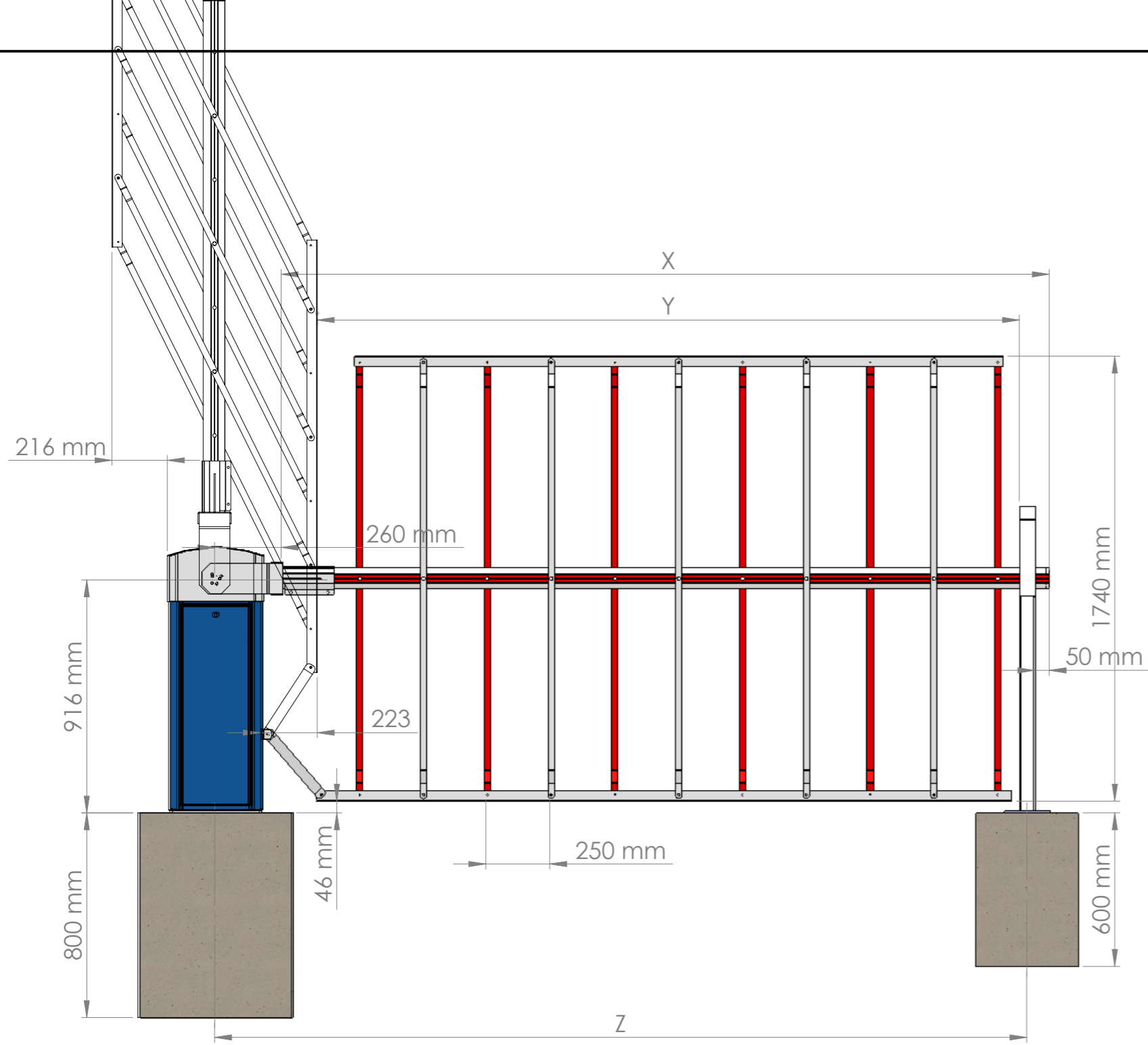

Longueur lisse X en mm	Largeur de passage Y en mm	Entraxe massifs Z en mm
3000	2700	3175
3500	3200	3675
3800	3500	3975
4000	3700	4175
4300	4000	4475
4500	4200	4675

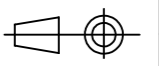
IND PLAN	B	MODIFICATION FAIT PAR	MIRKOVIC.Y	DATE	24/02/2014
CE PLAN EST LA PROPRIETE DE LA BARRIERE AUTOMATIQUE. REPRODUCTION OU COMMUNICATION A DES TIERS INTERDITE.					
Dessiné par:	MIRKOVIC.Y	Date:	30/12/2013	Vérifié par:	
Tolérance générale suivant ISO 2768		Classe :	mK	Nom Client:	
 451 chemin de Champivost - BP85 69579 LIMONEST Cedex Tel: 04.78.86.02.86 Fax: 04.78.51.18.76 WWW.barriere-automatique.com			Désignation : LBA7 ovale avec GTH		
Echelle	1:20			Numero Affaire	
Format	A3			Plan générique	

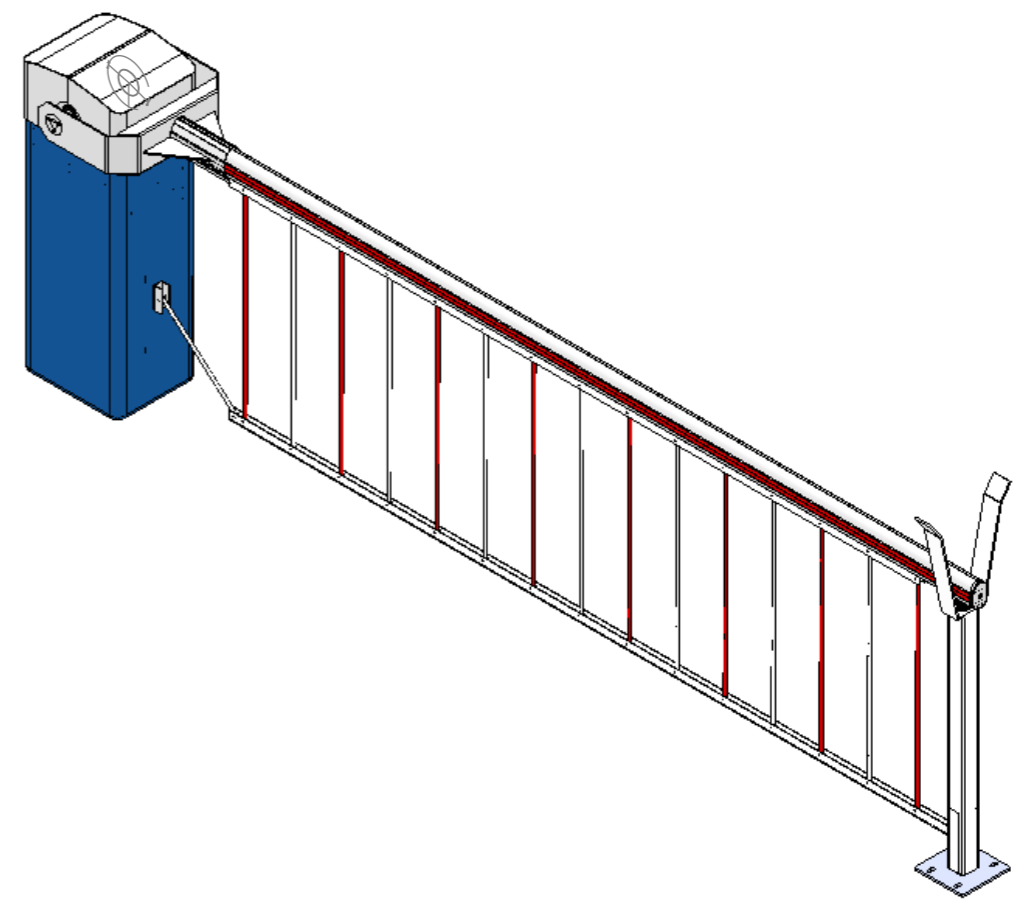
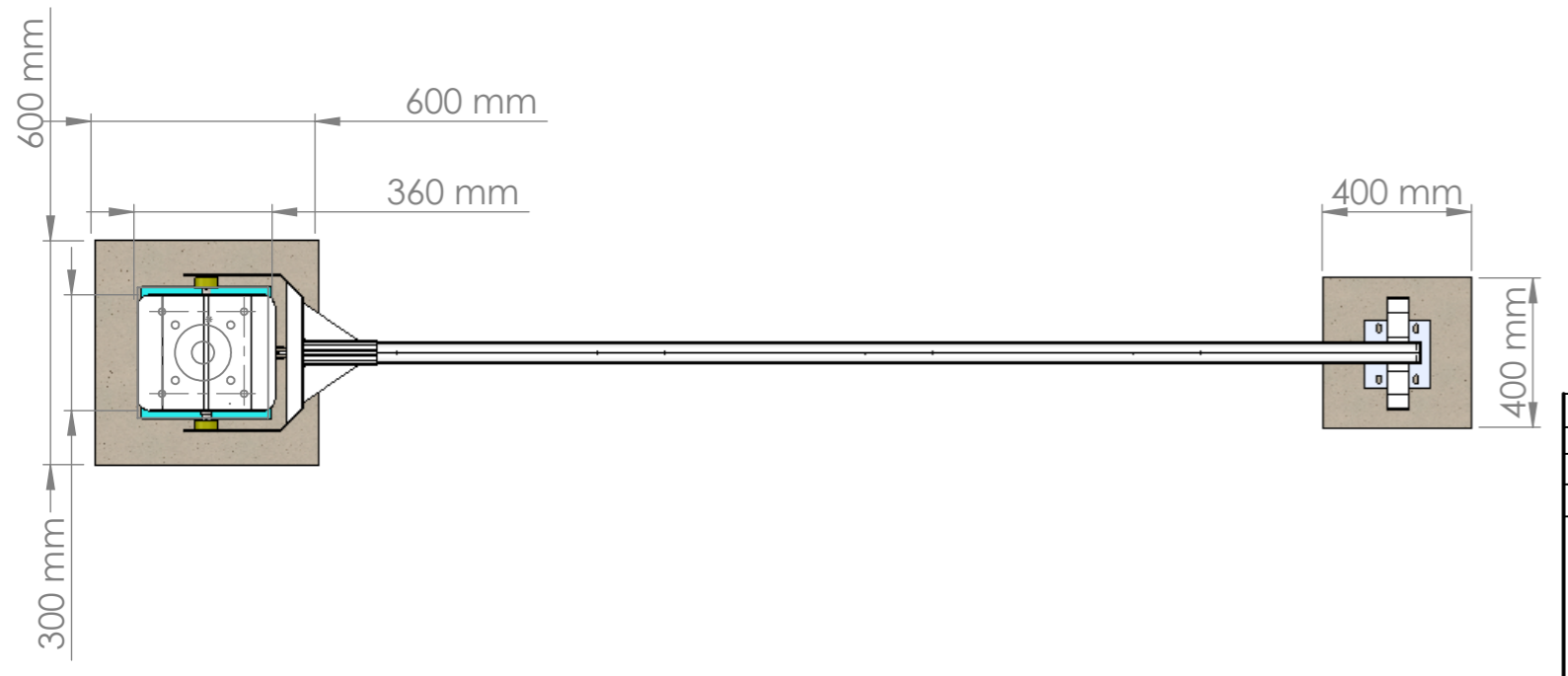
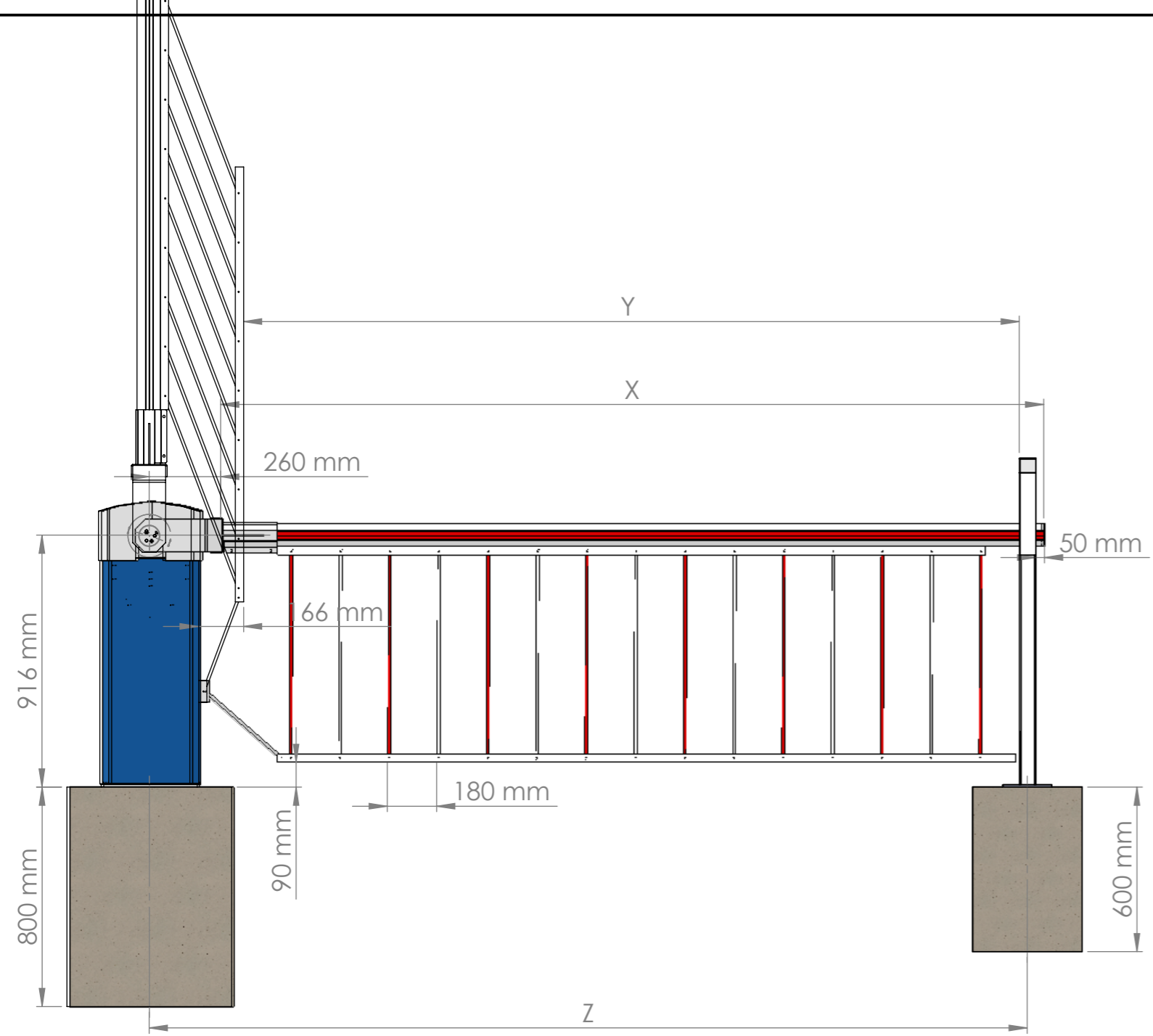

Longueur de lisse X en mm	largeur de passage Y en mm	Entraxe massifs Z en mm
3000	2800	3200
3500	3300	3700
4000	3800	4200
4500	4300	4700
5000	4800	5200

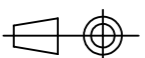
IND PLAN	B	MODIFICATION FAIT PAR	MIRKOVIC.Y	DATE	24/02/2014
CE PLAN EST LA PROPRIETE DE LA BARRIERE AUTOMATIQUE. REPRODUCTION OU COMMUNICATION A DES TIERS INTERDITE.					
Dessiné par:	MIRKOVIC.Y	Date:	30/12/2013	Vérifié par:	
Tolérance générale suivant ISO 2768		Classe :	mK	Nom Client:	
		451 chemin de Champivost - BP85 69579 LIMONEST Cedex Tel: 04.78.86.02.86 Fax: 04.78.51.18.76 WWW.barriere-automatique.com		Désignation : LBA7 lisse ovale avec GA	
Echelle	1:20			Numero Affaire	
Format	A3			Plan générique	
					1/1